

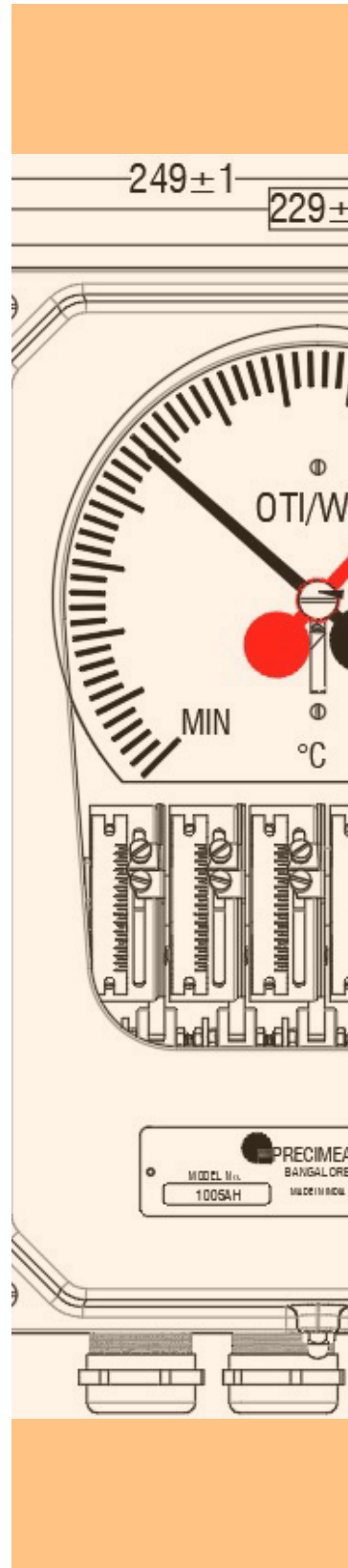

PRECIMEASURE

Protection and Beyond....



INSTRUCTION MANUAL

1005A SERIES INSTRUMENTS

CONTENTS

SL NO.	DESCRIPTION	PAGE NO.
1	Know your Instrument	1
2A	General Information	2
2B	Technical Specifications	
2C	Safety Instructions	
2D	General Warnings and Cautions	3
3	What is in the box	
4	Preliminary Checks and Procedures	
5	Instrument Handling and Care	4
6	Pre-Installation Checks & Procedures	4-8
7	Installation	9
8	Post Installation Handling	10
9	Maintenance	
9A	Storage Instructions	
10	FAQs and Trouble Shooting	11-12
11	Ordering Replacement parts	13
12	Warranty	
13	Contact Support	
ANNEX	Standard Scheme Drawings	14-15
ANNEX	Reference Images	16-17



Warning symbol: Content mentioned is to be mandatorily followed; failing which there could be serious injury to life



Caution symbol: Content mentioned is to be mandatorily followed failing which there could be damage to the equipment or property of the user and functionality of the equipment could be compromised



Note symbol: Other important information relating to the better performance of the equipment

OTI: Oil temperature indicator

WTI: Winding temperature indicator

CCU: Current converter unit

PSU: Power supply unit

RI: Remote Indicator

CT: Current Transformer

1. Know your Instrument:

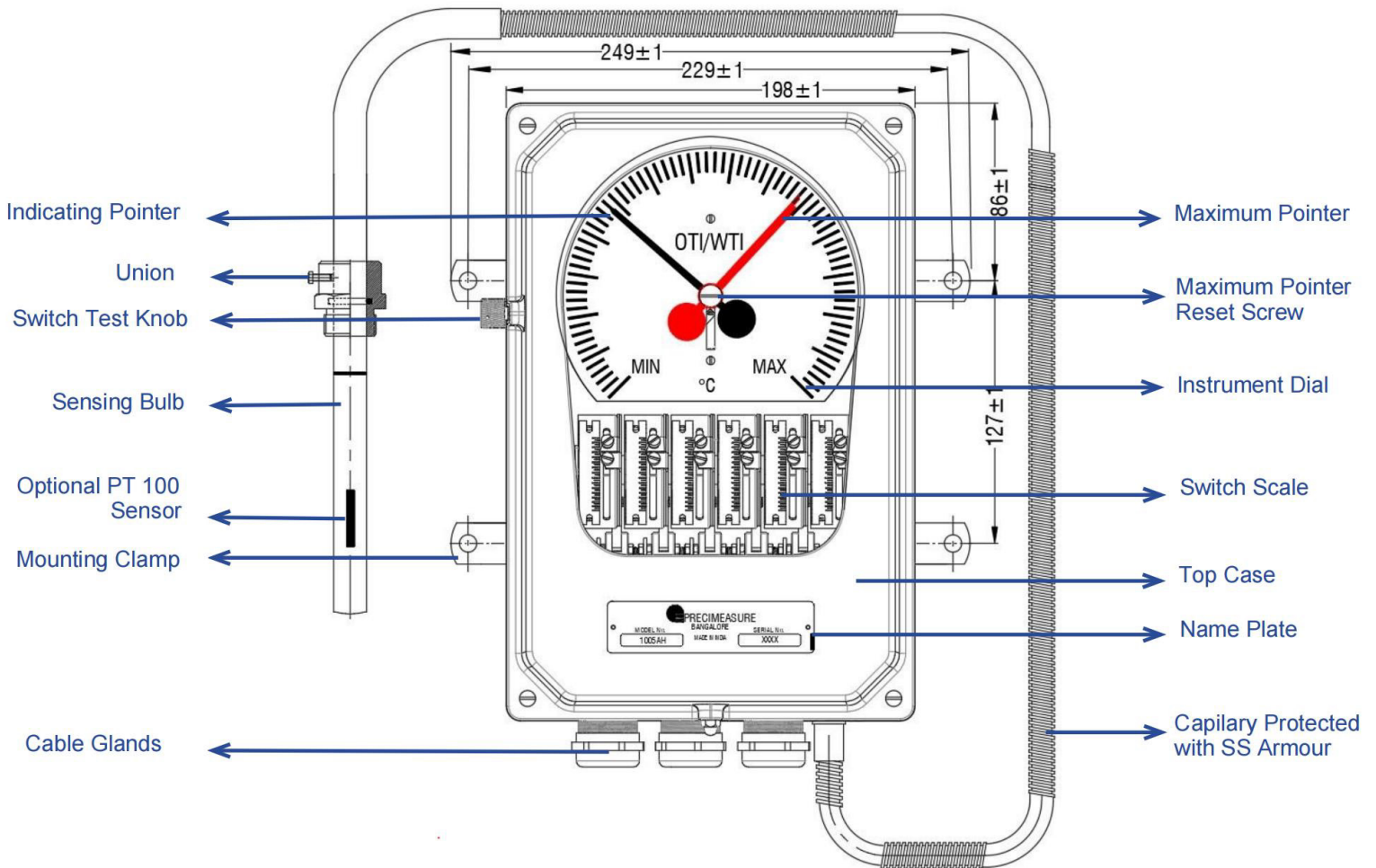

2. A. General Information:

Precimeasure's 1005A series is a precision Micro switch instrument known for its high performance, offering an accuracy of $\pm 1\%$ of FSD. It is designed for monitoring, indicating, and controlling temperature to safeguard Power / Distribution Transformers, Reactors, and Industrial Process Control Equipment. Additionally, it can simultaneously transmit data for Remote Indication or SCADA facility. The instrument comprises a Dial type Indicator, Capillary covered by Armour, Sensing bulb, and can be used with an External PSU, Remote Indicator, or both.

2. B. Technical Specification:

- Standard enclosure EN5 is made of aluminum pressure die cast & is polyester powder coated to corrosion category C2M ISO 12944-6 & color Shade 631 of IS5. It is compliant with basic Ingress Protection of IP55 as per IEC60529. In case your order calls for advanced specification, this will reflect in the test report.
- Dial Range: Standard Range is 0 to 150, Black background and white text. Or White background with black text. Standard graduation is 1 degree. In case your order calls for advanced specification, this will reflect in the test report.
- Window glass – UV resistant polycarbonate.
- Micro switches (max 6 no's). Standard instruments contain potential free micro switches. Refer drawing for switch rating, wiring type (Normally open / Changeover contact type) & switch differential settings.
- Cable entry - Standard Electrical entry is from bottom of case. Refer drawing for wiring details & cable entry options M20 / PG16 / M25.
- Capillary – Protected with Stainless Steel Armor. Standard instrument is with bottom entry.
- Refer catalogue, drawing of hybrid version for Remote indication / SCADA interface



2. C. Safety Instructions:

- Personal Protective Equipment to be used (PPE):
 - Insulated safety Shoes
 - Insulated Gloves
- It is recommended that the user read the instruction manual in its entirety before installation of the equipment. All precautions, Warnings and cautions to be taken into consideration before installation of the equipment failing which PRECIMEASURE cannot guarantee the performance of the equipment.
- Equipment and implements needed for successful installation
 - The vertical mounting surface to be flat & mounting holes as per our drawing to be provided
 - Continuity Tester
 - Multimeter
 - Current Source
 - Oil bath
 - Standard Screwdriver and spanner set



2. D. GENERAL WARNINGS AND CAUTIONS:

- **DO NOT WORK ON ENERGISED EQUIPMENTS AND COMPONENTS.** Suitable de-energizing shall be done prior to handling the equipment or necessary isolation from energized components shall be given prior to handling the equipment.
- **DO NOT MANUALLY OPERATE ANY CONTACTS WHEN EQUIPMENT IS ENERGIZED.** This will lead to possible false alarms or trips and will impact the performance of the equipment
- **DO NOT USE EXCESSIVE FORCE ON ANY PART OF THE EQUIPMENT.** This will cause the equipment to be damaged and malfunction.
- Only Technically trained / Authorized / Competently Qualified person to Handle / Operate the instrument at all the stages.
- It is strictly prohibited to Alter / tamper / Rework the instrument at any stage of usage. The Warranty of the instrument will not be valid incase such damage is noted.
- Improper handling leading to physical damage or usage beyond specification limits, leads to instrument failure immediately or over a time. This may be against safety of instrument/ person / customer assets.
- For any clarification, please contact Precimeasure.

3. BOX CONTENTS:

Instrument – As per customer requirement. Refer the Packing Slip on the box.

Electronic supplement – As per customer requirement. Refer the Packing Slip on the box.

Test Certificate - 1 physical copy of TC will be in the box. Request for E-Copies if needed.

Packing material –

Inside: Instrument is cushioned in a Biostable polyurethane foam.

Outside: Packed with 5 ply carton box with protective coat to safegaurd the instrument from environmental elements.

4. PRELIMINARY CHECKS & PROCEDURE:

Check for physical damage of the packing box caused during transport and handling. Please inform factory immediately on suspicion of transit damage.

Take the instrument out of the box by holding the body of the instrument (**DO NOT pull the capillary or sensing bulb while removing from the box**).

Ensure all the items are available with respect to the purchase order.



Inspect visually the Instrument & sensing bulb for physical damage & if ok, after 30 minutes of cooling time outside of the box, check for Ambient Temperature of the Instrument.

In case of any doubt, take a photograph of instrument and contact Precimeasure for more information.

5. INSTRUMENT HANDLING & CARE:-

Handle the Instrument with utmost care.

DO NOT twist the armor or capillary while unwinding, storage or installation.

DO NOT bend the armor or capillary too sharply. Min bend radius is 75 mm.

DO NOT carry the instrument by holding only the armor or capillary.

Sensing bulb is sensitive. No extra external force shall be applied on it.

Before storing or transportation, wind the armor and pack the instrument in the same way as received from the factory.

Excess armor or capillary after installation can be wound in a spiral of 100 mm radius and fixed on the transformer tank and secured with plastic cables ties for protection against any physical damage.

The excess capillary *should not be* placed near the earthing plate / near any electrical supply / HT cables.

6. PRE-INSTALLATION CHECKS & PROCEDURE:-



Check if the PO, drawings, test report & instruction manual meet your requirements.

Read the Instruction manual in full before Installation.

Ensure all necessary tools are available for installation.

Identify the *wiring diagram sticker pasted on the instrument topcase's right side in closed condition* and ensure you have understood the connection requirement.

Please contact Precimeasure in case you need any assistance.

6A. Check Instrument Calibration and Contact Calibration:-

a. Mount the temperature Indicator on Test Stand Vertically. Refer Figure 1, 1A, 2 and 2A for mounting dimensions.

b. Connect the following as per wiring diagram of instruments and refer your purchase documents for Scheme drawings. Typical Scheme drawings are given in annexure 1 of this document.

I. Micro switch terminals with multimeter / Buzzer (for Continuity test).

II. "Thermal image" or bellow heater terminal (CT Terminal) with current source.

III. "Transmitter" Remote indicator terminal (CCU output Terminal) with remote indicator / PSU / 24V DC source as applicable.

IV. Close the Top cover.

c. Set oil bath temperature at 40°C, with reference to the standard Thermometer.

d. Loosen union screw to remove the union and immerse sensing bulb in hot oil bath (Ensure min. immersion length as per Figure.3).

e. Allow the bath to reach the steady temperature. Record the instrument temperature after 5 minutes.

f. Increase the oil bath temperature in steps of 20°C till maximum and record the temperature of the instrument 5 minutes after the bath reaches the steady temperature.

- g. Simultaneously observe and record the switch operation (ON) as instrument temperature rises.
- h. Remove the sensing bulb from oil bath and keep in ambient temperature till the instrument reading reaches the ambient temperature.
- i. Simultaneously observe and record the switch operation (OFF) as instrument temperature decreases (To check switch differential).

6B. Switch Setting:-

Switches are factory set as per customer requirement as mentioned in the purchase order or as per Precimeasure standard setting of S1 at 80, S2 at 90, S3 at 60 and S4 at 70. Change the switch setting only if the requirement has been changed. DO NOT unnecessarily change the switch setting. ***Switch rating sticker is pasted on the left side of the bottom case of the instrument.***

j. The switches are Normally Open Heavy Duty Micro Switches, rated as shown in figure 4. Switch contacts are potential free with differential fixed at 3°C to 9°C for S1 & S2 switches and adjustable differential of a range from 8°C to 40°C for S3 to S6 switches (cooler control). Accuracy of switch setting is $\pm 2.5^\circ\text{C}$ of set value.

k. Tools needed:

- To remove top cover M4 screws use flat screwdriver (1.0*6.5) or star screwdriver.
- Use Medium size flat screwdriver (0.8*5.5) to unscrew/ fasten switch setting screw.

l. **Switch Setting:** Refer figure 5.

- Each switch is individually adjustable and provided with a switch scale.
- Loosen the knurled-head switch setting screw on the red pointer and set at required temperature.
- Tighten back the screw.

m. **Switch differential setting:** Refer figure 5.

- Loosen the knurled-head switch differential setting screw on the blue pointer and set at required differential temperature. The adjustable range is from 8°C to 40°C.
- Tighten back the screw.

6.C Check WTI temperature raise calibration:

n. Set the Hot oil bath temperature at 60°C, Immerse the sensing bulb

o. Inject the rated current as per requirement or Graph, for 40 minutes, and check the temperature rise of winding temperature over oil temperature.

p. If required, Keeping CT secondary current constant, temperature rise can be adjusted up to $\pm 3^\circ\text{C}$ through shunt which is been provided, by increasing / decreasing the shunt screw. Refer figure 6 for the image of shunt adjustment



- **Note:** Refer the Gradient Sticker pasted on the left inner side of the bottom case for the instrument's gradient settings. Do Not Pass current in excess of the rated current as per gradient sticker as passing excess current will damage the instrument.

For renewable application where overload is expected, please contact Precimeasure.

6.D Gradient Adjustment Procedure:



IMPORTANT NOTE:

- Gradient can be adjusted only to a certain limit with respect to the factory gradient settings.
 - *Check with Precimeasure before making any changes to the shunt and gradient. Changes made without prior information will render the instrument warranty null and void*
 - *Incase of renewable energy applications, DO NOT make any changes to the gradient settings at site.*
 - The instruments factory gradient settings will be available in the *Gradient Sticker pasted on the left inner side of the bottom case.*
 - You can also see the Shunt resistance attachment on the top left side of the instrument, just next to the dial.
- Follow the below steps carefully to make any adjustments:

Instruments and informations needed:

Ohm Meter with three decimal point resolution and a Screw driver set.

Gradient Graph - Please contact Precimeasure for your instruments Gradient graph. This graph is not a standard graph and can vary with each instrument. A standard graph is given in the next page for reference

Calculations:

I1 - CT Current | I2: Bellow Heater Current | RS: Shunt Resistance | T: Temperature raise over top oil.

- Using the BH Graph identify I2 in the X axis corresponding to the required Temperature raise in the Y axis.
- Calculate I2 / I1. Use this value and identify the RS value in the X axis from Matching Resistance graph. This RS value is the resistance that the adjustable shunt in the instrument needs to be reset to.

Procedure:

- Disconnect CT connection at terminals (5-5) or (9-11) - refer your wiring diagram.
- Connect the three decimal point ohm meter across the CT terminals (5-5) or (9-11).
- Identify the Adjustable shunt located in the top left side of the instrument and its center band.
- Slacken the center band screw by approximately half round, in anticlock wise direction to loosen it.
- Turn the shunt adjusting screw till ohm meter reads the calculated matching resistance value (RS) as above.
 - To reduce the gradient: turn shunt adjustment screw anti-clock wise.
 - To increase the gradient: turn shunt adjustment screw clock wise.
- Tighten back the center band screw to secure the center band and the shunt.



Note: Shunt adjustment screw should be turned slowly & softly.

Gradient reading should be tested only with the top case fully secured to the instrument.

Standard BH graphs.

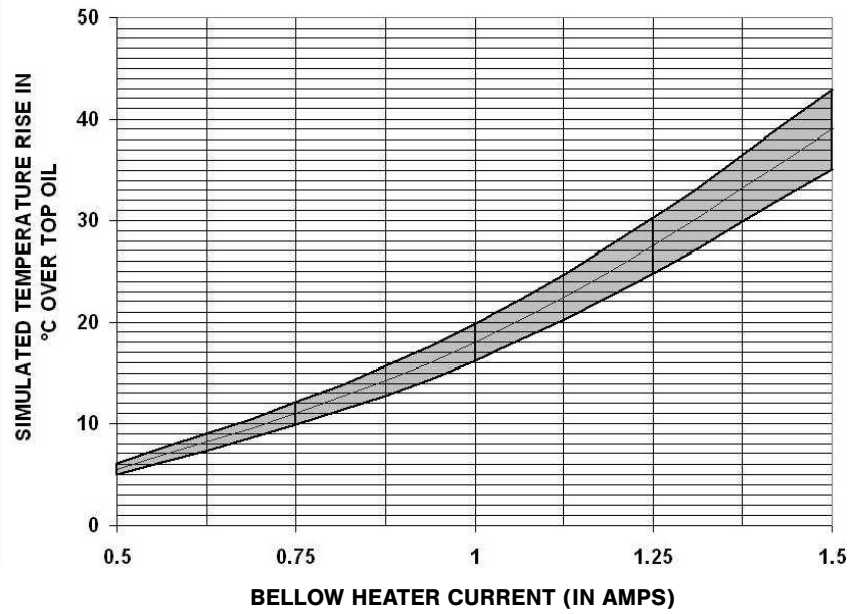

Oil Temp. 30°C/60°C	Gradient °C										
	10	12	14	16	18	20	22	24	26	28	30
	0.71	0.79	0.87	0.94	1.0	1.06	1.11	1.16	1.21	1.26	1.31
Heating Current in Amps $I_2 \pm 5\%$											

Standard Matching Resistance graph.

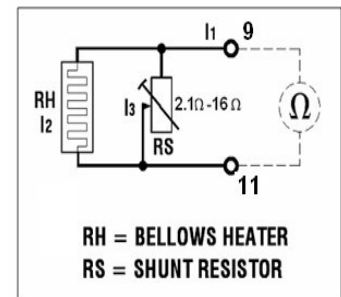
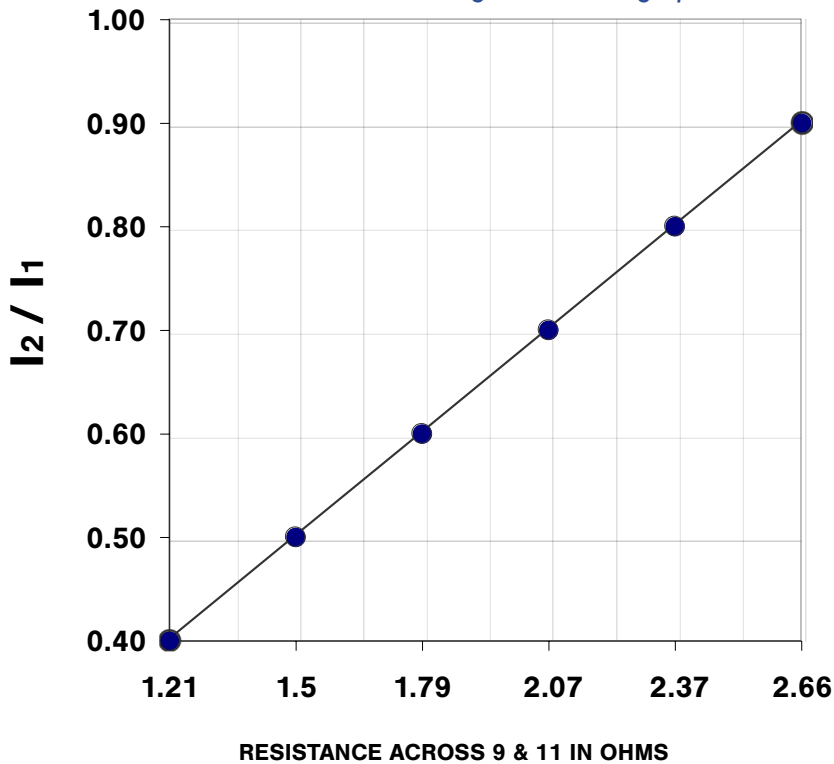

Example for Gradient Calculation:

Required CT Secondary Current $I_1 = 1.5A$ with temperature raise $15^\circ C$

As per BH Graph above $I_2 = 0.9A$ for $15^\circ C$ Temperature raise.

Calculate $I_2/I_1 = 0.9 / 1.5 = 0.6$.

As per Matching resistance Graph, Resistance value for 0.6 is 1.79.

Resistance value accross CT terminals is to be set to 1.79 Ohms using the method detailed in point 6D above.

6.E Testing for HV:-

 **Caution:** - The instrument has been tested for 2.5KV & 0.5KV at works. In case the HV test to be repeated, then Set trip setting current to 40mA in HV tester, as line filter has been incorporated in the instrument circuit.

 **Note:** HV test is conducted in factory. If it is to be repeated at customer place or site, HV test to be conducted at 80% of the original value only. I.e., Max of 2 KV and 0.4 KV respectively.

- Conduct the High voltage test between micro switch terminals and "Thermal image" bellow heater terminal (CT terminals) to body at 2.0 KV AC 50Hz / 60Hz for 1 minute.
- Conduct the High voltage test between "Transmitter" Remote indicator terminals (CCU output terminals) to body at 400V AC 50 Hz for 1 minute.
- Remote indicator: Power supply input terminal to body 2.0KV AC 50Hz / 60Hz for one minute.
- RI Output terminal & Local OTI/WTI input terminal to body 400V AC 50Hz / 60Hz for one minute.
- PSU: Power supply input terminal to body 2.0KV AC 50Hz / 60Hz for one minute
- PSU Output terminal & Local OTI/WTI input terminal to body 400V AC 50Hz / 60Hz for one minute.

6.F Ambient Testing

Immerse the sensing bulb in to the well-stirred water or oil bath up to the Immersion Length as shown in the Figure-3. Keep the bath temperature at $40^\circ C$, Use Standard Thermometer or a calibrated Standard Digital Thermometer for comparing with the instrument. Take the reading indicated by the instrument after five minutes and compare with the thermometer reading. The reading should be within accuracy.

7. INSTALLATION:-

- a. Keep the instrument on mounting surface (Ref. Figure-1, 1A, 2 and 2A for Mounting Dimension) and fix it.
- b. Make sure that instrument is mounted in vertical position.
- c. Ensure the anti-vibration mount is fixed properly and optimally tightened as shown in figure-1A.
- d. Ensure Capillary / Armor is not twisted, damaged while routing or clamping.
- e. Avoid sharp bends of armor and allow minimum of 75mm Radius (Ref. Figure-7). Extra armor, if any to be secured properly, without damage.
- f. Route the armor from the sensing probe to the instrument head and clamp it in approximately 500 mm intervals.
- g.  ***Fill appropriate quantity of oil in thermometer pocket, & ensure sensing bulb is completely immersed in oil when fixed.***
- h. Remove union / pocket from sensing bulb. Tighten it on the transformer fully. Insert the sensing bulb through union/pocket / flange (insert fully), Adjust to required direction, tighten locking screw to optimum
 - i. Care must be taken that, sensing bulb is not damaged while Insertion in pocket / tightening union or screw.
- j. Ensure that Earthing is made properly.
- k. Recommended to compulsorily use appropriate size of cable gland for all electrical wiring. Else close all glands holes using blanking plugs.
- l. A maximum indicating pointer in red color is fitted to the instrument window glass. Ensure to reset this using a standard screwdriver by turning the screw and making the maximum pointer touch the indicating pointer.
- m. All electrical connections are provided through press fit type terminal blocks. A wiring diagram of these connections is provided inside the case.
- n. The connection shall be made as shown in the wiring diagram. Check and confirm connection via a continuity tester.
- o. Cable Recommendation: From OTI/WTI's CCU output terminal / PSU to SCADA system: Armored 2core, 2.5sqmm twisted copper cable to be used and not to exceed 1km. The shield or armor should be earthed at one end and should not run along with the power supply cable. Communication cable should be laid at least 0.5 meter away from power cables in separate tray.
- p. The auxiliary supply for PSU (which is installed at Marshaling box) Armored 3core, 2.5sqmm twisted copper cable to be used and not to exceed 1km. Shield or Armor should be earthed at one end.
- q. Ensure that the top case is fully secured and all 4 screws are tightened properly.

8. POST INSTALLATION HANDLING:-

- a. Do not interchange the top case as serial numbers of the instruments are tracked on the top Case. (It will be difficult to trace the instrument if top case gets interchanged).
- b. Ensure no loose connections for switches, CT terminals and RI. Only recommended cable is used for remote indicator wiring
- c. Check for switch operation using Switch Test knob. For easy operation, turn in an anti-clockwise direction slowly, & release to rest position. After check, disable it by tying a binding wire. This is to be used only at the time of final installation review. This option should not be used after commissioning or on an energized transformer.

9. MAINTENANCE:-



OTI/WTI health testing is required for the first year of installation. First check is recommended at 6 months after installation and second check at the end of 12 months from the date of installation.

Subsequently as a procedure the instruments can be checked at the time of routine transformer maintenance (preferably once a year) to check the operation of switches and overall accuracy of the reading. If the said parameters found within accuracy in the instruments, then further calibration is not required. If the parameters are beyond the accuracy level (Eg: 5 deg C error / less or more than actual temperature) then calibration of the instrument is necessary. You can contact Precimeasure for further assistance.

Note: For Electronics instruments no calibration is required post installation.

9A. STORAGE INSTRUCTIONS:-

- a. Packed box to be stored in a neat and clean place and should be prevented from rainwater and external damages.
- b. Packed box to be stored in the temperature from 0°C to +60°C.
- c. Instrument should be in closed condition with proper packing as supplied by Precimeasure.
- d. Before re-packing, keep silica gel packets for moisture absorption. Silica gel packets may be changed as frequently as required based on humidity in the storage area and quantity of gel used. Note: silica gel is not supplied with the instruments as a standard practice by Precimeasure.
- e. External box should be wrapped with polythene cover to protect from water.
- f. Box to be stored in the place where not accessible from rats or any other rodents.
- g. Do not keep near other metals that are susceptible to corrosion Eg. Iron, Copper etc...

10. FAQ / TROUBLE SHOOTING:-

a. Discrepancy / Error in WTI/OTI readings at field / site.

- I. Thoroughly inspect capillary / armour & sensing bulb is not damaged. Even a small dent induced while installation, or over tightening of union fixing screw can lead to error in reading.
- II. Check for sensing bulb immersion as per requirement, & sufficient oil in thermometer pocket for effective heat transfer.
- III. Ensure the capillary of OTI/WTI from head of the instrument to thermometer pocket should not run along with any HT cables / any earth plate etc.
- IV. Remove the sensing probe of both OTI / WTI from the thermometer pocket and check for ambient temperature in oil bath, refer point 6F.
- V. If the temperature reading is found beyond declared accuracy contact Precimeasure.

b. After charging the Transformer, OTI Temperature is more than WTI temp.

- I. Check the accuracy of both OTI and WTI independently as per the procedure mentioned above in 10.a.
- II. Check the temperature rise as per the gradient graph as per procedure mentioned in 6C. The CT current and raise is to be as per the gradient sticker placed inside the instrument.

c. WTI Gradient error:

- I. The gradient has been calibrated in WTI while manufacturing as per the P.O specification.
- II. A provision is made for gradient adjustment at OEM / site. For details refer point 6D Please call Precimeasure for assistance. Any wrong adjustment can lead to fatal accidents.

d. Water condensation on window glass of OTI/WTI:

- I. If the top cover of the instrument is not fixed properly then there are chances of water entering inside the instrument, leading to condensation of water on inside of window glass.
- II. We suggest removing the top cover, cleaning it with a cloth. Apply warm air to dry both top & bottom case. Fix back the top case.
- III. Ensure the cable glands are tightened fully to avoid water entering inside.
- IV. In the process, if rust is found on any internal component, call Precimeasure for assistance. If instrument is not safe to use, replacement may be initiated.
- V. Further following additional inspections to be conducted.
 - Top case Gasket: Check for cracks, cut, deformation etc. Recommended to Replace gasket every 3 years to 5 years, depending on environmental conditions
 - Check that silicone sealant between the window glass and Aluminum top case is intact and no gaps are found. Ensure there is no leakage through this joint.

e. Switch not operating: Refer point 6B

Call Precimeasure for further assistance.

f. Showing erratic reading in SCADA system.

- I. Check for auxiliary supply availability.
- II. Check for wiring continuity, loose contacts & terminals polarity as per scheme drawing.
- III. Check for proper Earthing.

g. 4-20mA output not coming from PSU

- I. Check for auxiliary supply availability
- II. Check for wiring continuity, loose contacts & terminals polarity as per scheme drawing.
- III. Between neutral point in PSU and any earth point in marshaling box / any earth pad should be below 5volts.
- IV. Disconnect wire from terminal number 14, & Connect Multimeter in series & check current output. Call Precimeasure for assistance.

h. Showing OUER indication in remote indicator.

- I. Disconnect wire from terminal number 14, & Connect Multimeter in series & check current output. Call Precimeasure for assistance.

i. Showing UNDR indication in remote indicator.

- I. Disconnect wire from terminal number 14, & Connect Multimeter in series & check current output. Call Precimeasure for assistance.

j. Showing OPEN indication in remote indicator

- xxiv. Check for auxiliary supply availability.
- xxv. Check for wiring continuity, loose contacts & terminals polarity as per scheme drawing.
- xxvi. Check for proper Earthing.
- xxvii. Disconnect wire from terminal number 14, & Connect Multimeter in series & check current output

k. In case of other errors - Call Precimeasure for assistance.

11. Ordering Replacement parts:

- a. Top case gasket.
- b. Anti-vibration mounts.

Note: - Rubber items last for 3 years to 5 years at normal environmental conditions & ambient temperature of 25°C from the date of manufacture. For more severe & harsh conditions, call Precimeasure for assistance.

12. WARRANTY:

Precimeasure's standard warranty is for a period of Twelve (12) months from the date of sale or Eighteen (18) months from the date of installation whichever is earlier. During this period, we warrant that the Equipment other than consumables will be free from defects in material and workmanship. It is Precimeasure's sole obligation under this warranty to repair or replace the defective parts at no charge to the Purchaser. All replaced parts shall become the property of Purchaser, however, they may require return to the manufacturer for inspection and warranty assessment. Precimeasure agrees to provide to Purchaser detailed terms, conditions and instructions for exercise of warranty if needed.

Excluded Claims: Precimeasure will have no obligation under this Agreement if: (1) repair or replacement of the Equipment or parts is required because of normal wear and tear or necessitated in whole or part by catastrophic or causes external to the Equipment, or (2) the Equipment has not been properly used or maintained in accordance with the applicable operating and maintenance manuals.

Limitation of Liability: Precimeasure's total liability to the Customer for damages, from any cause whatsoever, and regardless of the form of action, whether in contract or tort, including negligence, is limited to actual damages up to the purchase price paid for the Equipment under the Original Purchase Agreement/ Order.

13. Contact Precimeasure for support:

E-mail: sales-bng@precimeasure.com / service@precimeasure.com

Address: Plot no-65, sompura industrial area, 1st stage,
Dabaspeta, Bangalore – 562111 INDIA.

Phone no: 080-66080109 / 080-66080106

Website: www.precimeasure.com

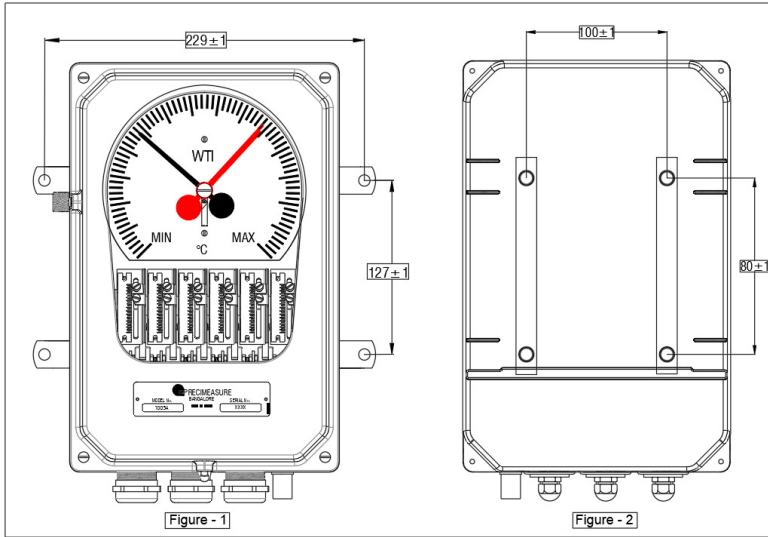

Overall arrangement

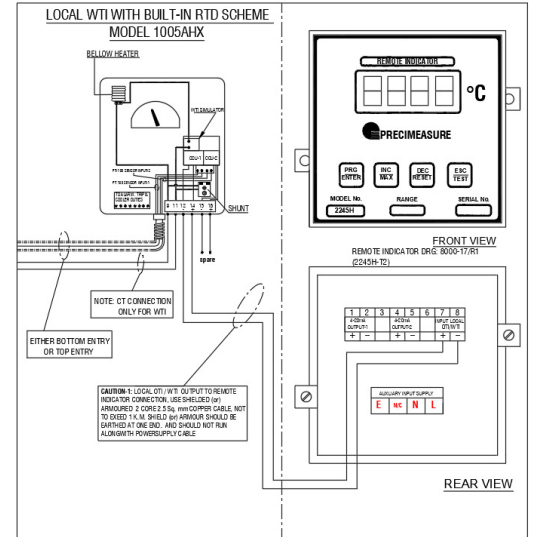

Duplex scheme with remote indicator

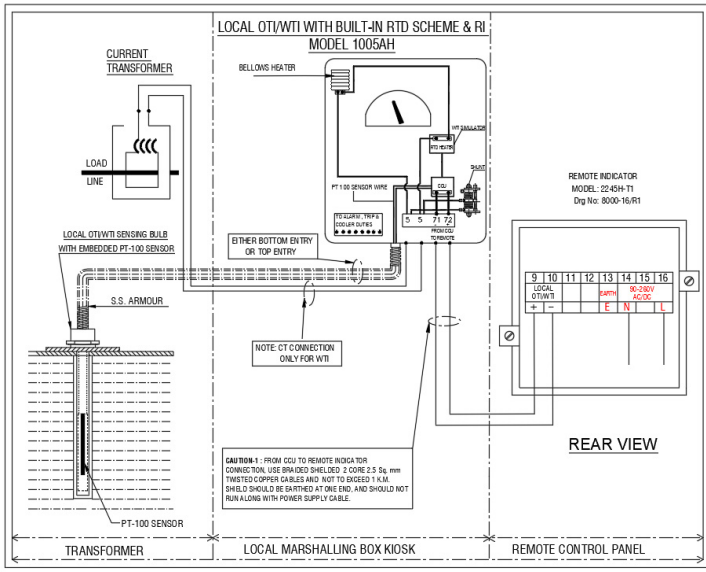

Simplex scheme with remote indicator

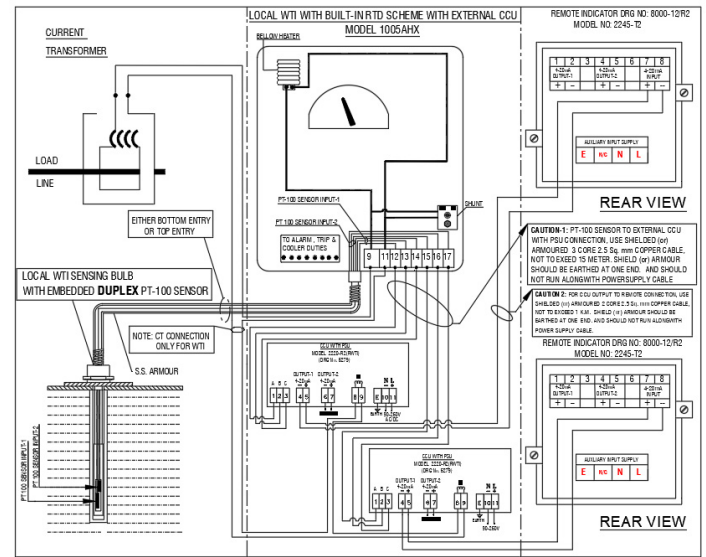

Duplex scheme with 2nos remote indicator

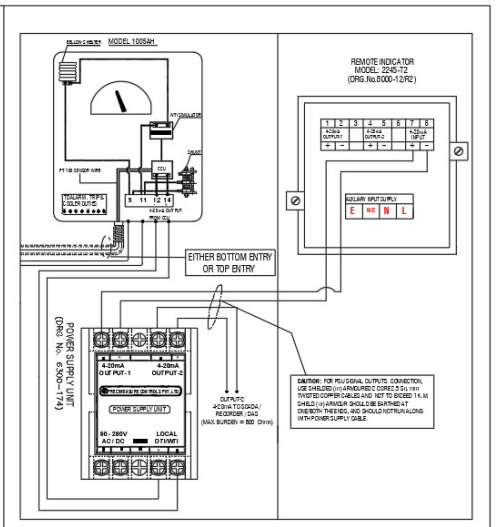
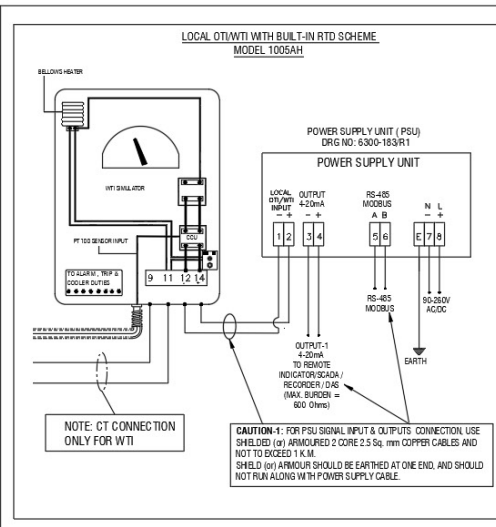
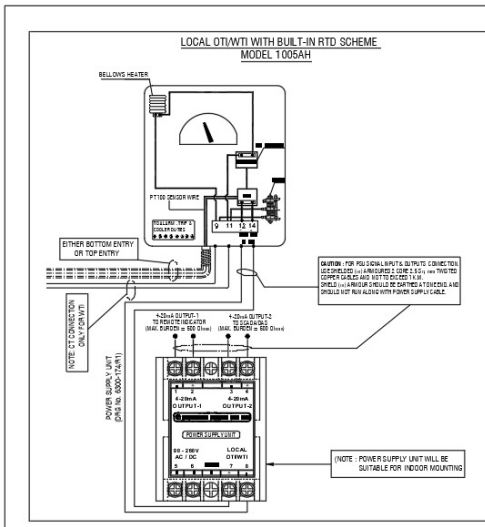

Simplex scheme with power supply units

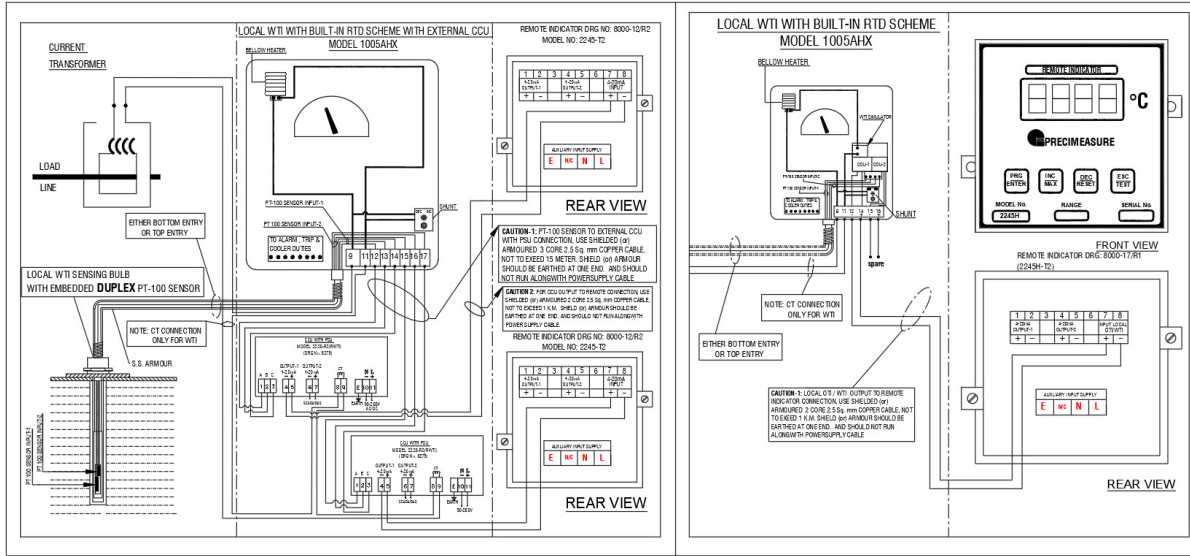

Duplex Scheme with external CCU

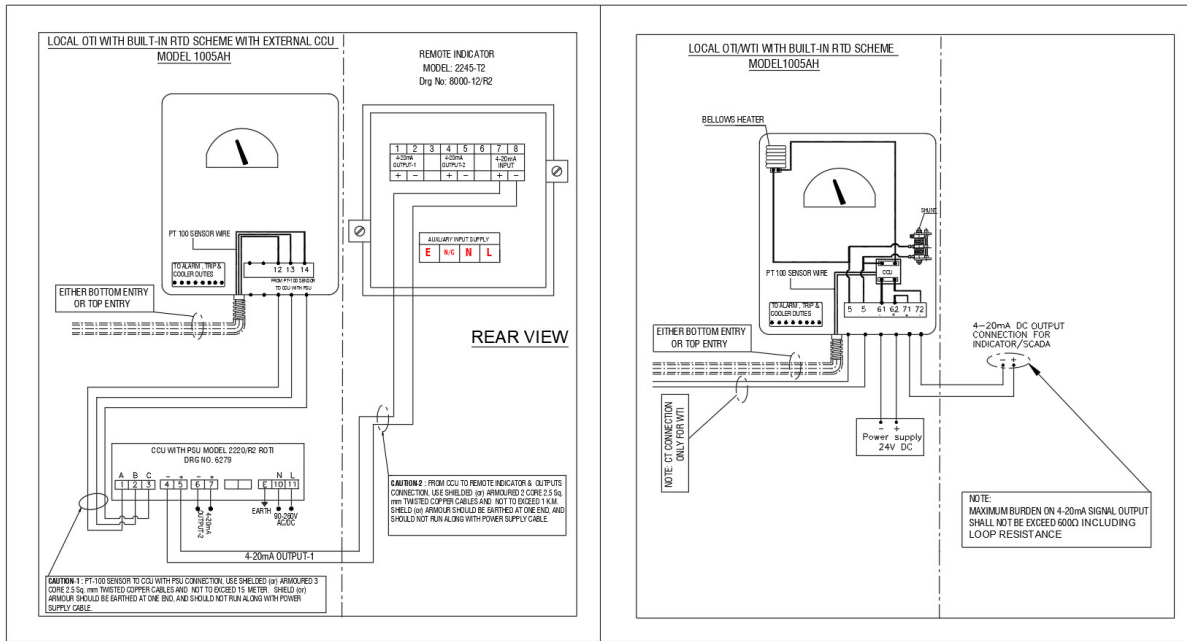

Simplex Scheme with external CCU

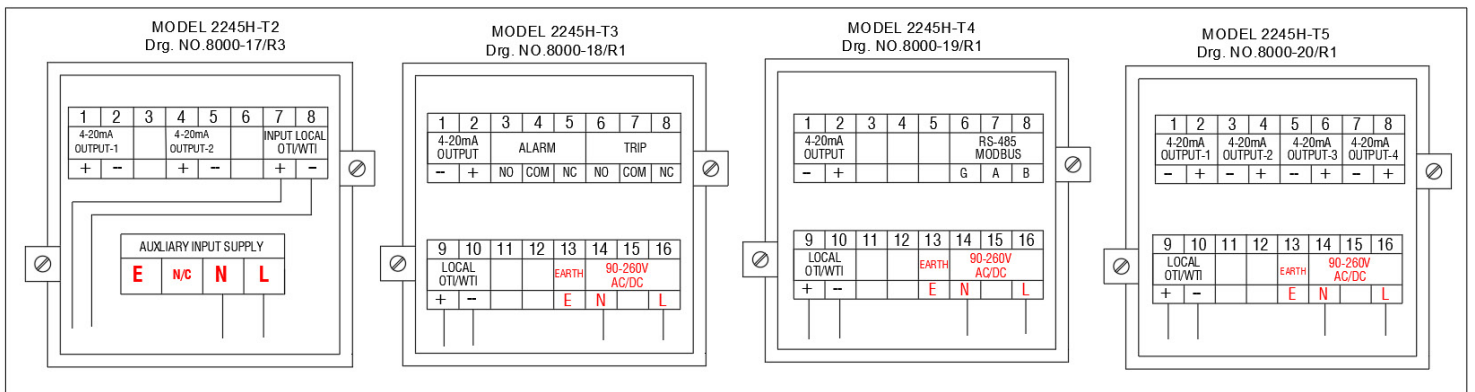

Types of Remote Indicators

Mounting Dimintions: Fig 1, 1A, 2 and 2A

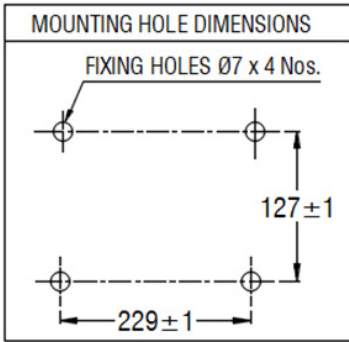

Figure 1

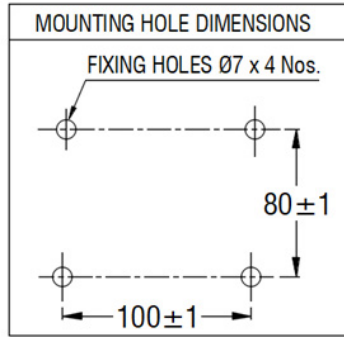

Figure 2

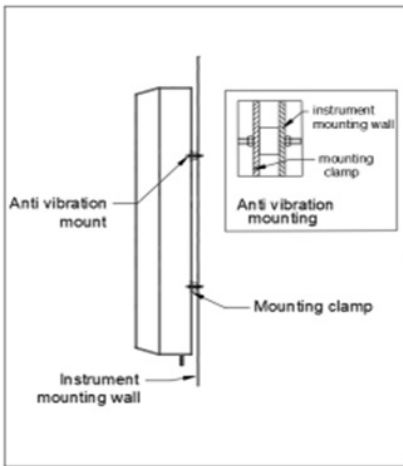

Figure 1A

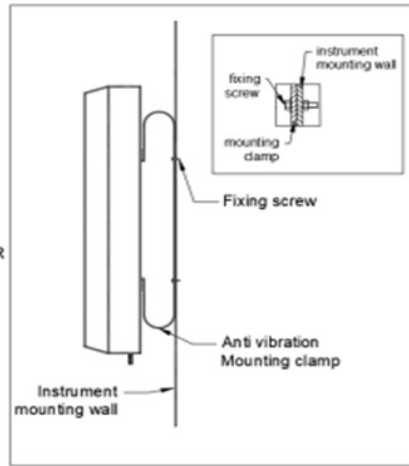
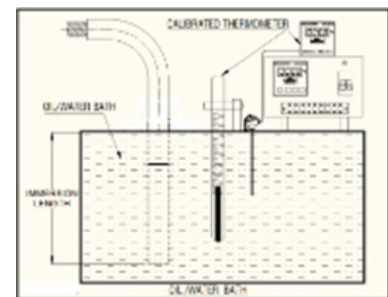
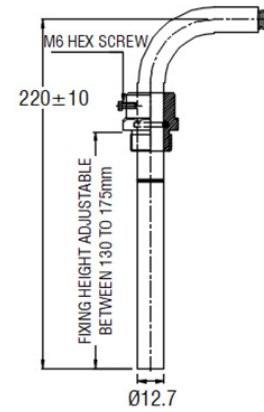

Figure 2A

Sensing Probe and Union Fixing:

Figure 3



RANGE	IMMERSION LENGTH
-20 TO +140°C	
0 - 150°C	140mm
0 - 160°C	
20 - 140°C	175mm
30 - 150°C	
0 - 240°C	100mm

Switch rating and configuration:

Figure 4

STANDARD MICRO SWITCH MAKING AND BREAKING SWITCH CONTACT RATING			
		RATED VOLTAGE	RESISTIVE LOAD
OPTION 1	STANDARD SWITCH	125 VAC	15A
		250 VAC	15A
		30 VDC	10A
		125 VDC	1A
		250 VDC	0.5A
OPTION 2	MBO	125 VAC	15A
		250 VAC	15A
		30 VDC	10A
		125 VDC	5A
		250 VDC	5A

*MBO - MAGNETIC BLOW OUT, HIGH DC SWITCHING,

Switch and Differential setting:

Figure 5

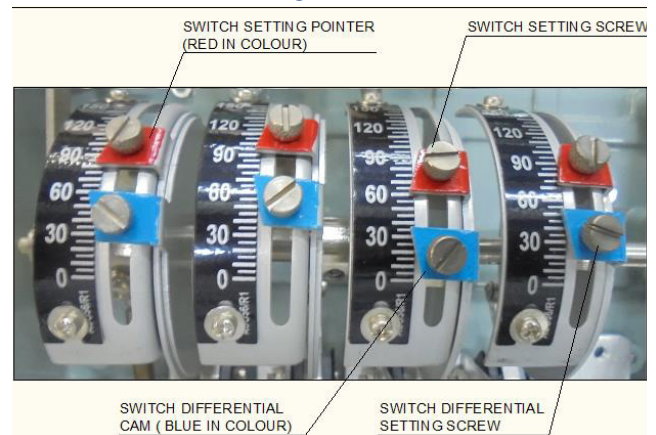

Shunt Adjustment: Figure 6

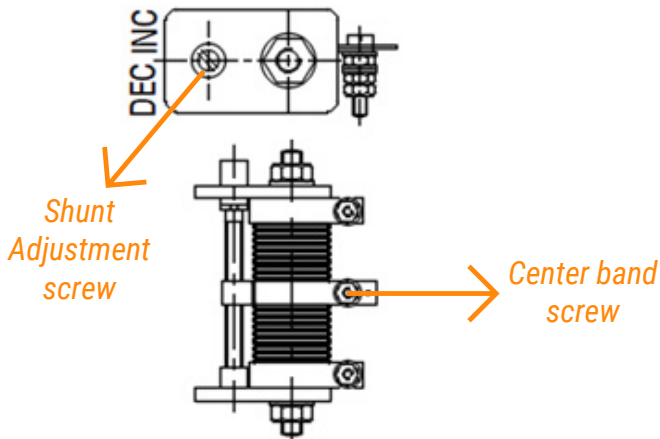

Minimum Bend radius of Capillary: Figure 7

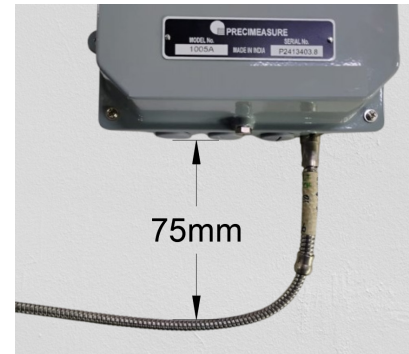

Standard contact wiring diagrams

For Hybrid Instruments

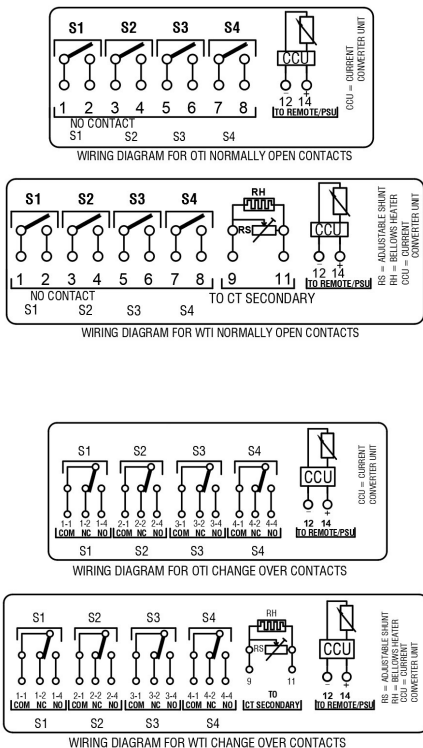

For Standard Instruments

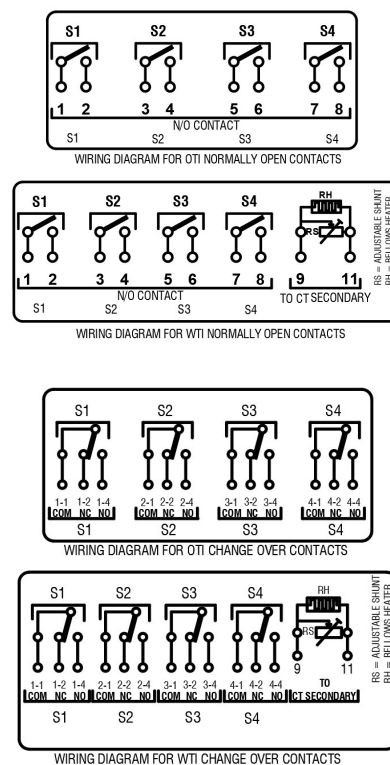

Refer the wiring diagram inside the instrument to know your instrument's switch configuration

DISCLAIMER: The material in this manual is for informational purposes only. The products it describes are subject to change without prior notice, due to the manufacturer's continuous development program. This document can undergo changes without prior notice or consent. These instructions do not purport to cover all details or variations in the product and do not claim to provide for every possible contingency met in connection with installation, operation, or maintenance. Should further information be desired or should particular problems arise which are not covered sufficiently for the purchaser's purposes, the matter should be referred to Precimeasure. This document is the intellectual property of Precimeasure and shall not be reproduced, copied, altered in any way or form.